

## NPN Silicon High-Voltage Transistors

- Suitable for video output stages TV sets and switching power supplies
- High breakdown voltage
- Low collector-emitter saturation voltage
- Complementary type: BFN39 (PNP)
- Pb-free (RoHS compliant) package<sup>1)</sup>
- Qualified according AEC Q101

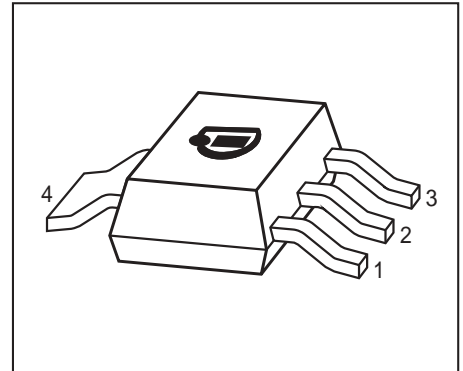

Type	Marking	Pin Configuration						Package
BFN38	BFN38	1=B	2=C	3=E	4=C	-	-	SOT223

### Maximum Ratings

Parameter	Symbol	Value	Unit
Collector-emitter voltage	$V_{CEO}$	300	V
Collector-base voltage	$V_{CBO}$	300	
Emitter-base voltage	$V_{EBO}$	6	
Collector current	$I_C$	200	mA
Peak collector current	$I_{CM}$	500	
Base current	$I_B$	100	
Peak base current	$I_{BM}$	200	
Total power dissipation- $T_S \leq 124 \text{ }^\circ\text{C}$	$P_{tot}$	1.5	W
Junction temperature	$T_j$	150	$^\circ\text{C}$
Storage temperature	$T_{stg}$	-65 ... 150	

### Thermal Resistance

Parameter	Symbol	Value	Unit
Junction - soldering point <sup>2)</sup>	$R_{thJS}$	$\leq 17$	K/W

<sup>1)</sup>Pb-containing package may be available upon special request

<sup>2)</sup>For calculation of  $R_{thJA}$  please refer to Application Note Thermal Resistance

**Electrical Characteristics** at  $T_A = 25^\circ\text{C}$ , unless otherwise specified

Parameter	Symbol	Values			Unit
		min.	typ.	max.	
<b>DC Characteristics</b>					
Collector-emitter breakdown voltage $I_C = 1 \text{ mA}, I_B = 0$	$V_{(BR)CEO}$	300	-	-	V
Collector-base breakdown voltage $I_C = 100 \mu\text{A}, I_E = 0$	$V_{(BR)CBO}$	300	-	-	
Emitter-base breakdown voltage $I_E = 100 \mu\text{A}, I_C = 0$	$V_{(BR)EBO}$	6	-	-	
Collector-base cutoff current $V_{CB} = 250 \text{ V}, I_E = 0$ $V_{CB} = 250 \text{ V}, I_E = 0, T_A = 150^\circ\text{C}$	$I_{CBO}$	-	-	0.1 20	$\mu\text{A}$
Emitter-base cutoff current $V_{EB} = 5 \text{ V}, I_C = 0$	$I_{EBO}$	-	-	100	nA
DC current gain <sup>1)</sup> $I_C = 1 \text{ mA}, V_{CE} = 10 \text{ V}$ $I_C = 10 \text{ mA}, V_{CE} = 10 \text{ V}$ $I_C = 30 \text{ mA}, V_{CE} = 10 \text{ V}$	$h_{FE}$	25 40 30	- - -	- - -	-
Collector-emitter saturation voltage <sup>1)</sup> $I_C = 20 \text{ mA}, I_B = 2 \text{ mA}$	$V_{CEsat}$	-	-	0.5	V
Base emitter saturation voltage <sup>1)</sup> $I_C = 20 \text{ mA}, I_B = 2 \text{ mA}$	$V_{BEsat}$	-	-	0.9	
<b>AC Characteristics</b>					
Transition frequency $I_C = 20 \text{ MHz}, V_{CE} = 10 \text{ V}, f = 20 \text{ MHz}$	$f_T$	-	70	-	MHz
Collector-base capacitance $V_{CB} = 30 \text{ V}, f = 1 \text{ MHz}$	$C_{cb}$	-	1.5	-	pF

<sup>1)</sup>Pulse test:  $t < 300\mu\text{s}; D < 2\%$

**DC current gain  $h_{FE} = f(I_C)$**

$V_{CE} = 10\text{ V}$

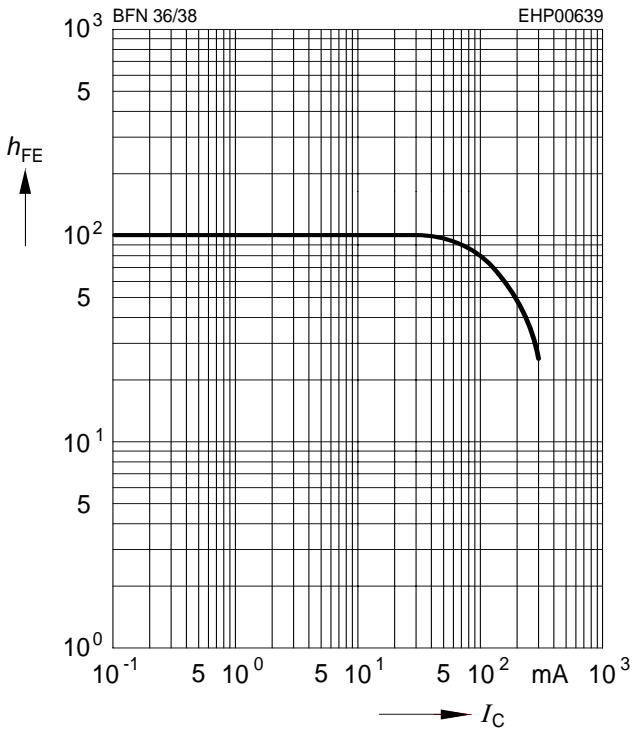

**Collector current  $I_C = f(V_{BE})$**

$V_{CE} = 10\text{ V}$

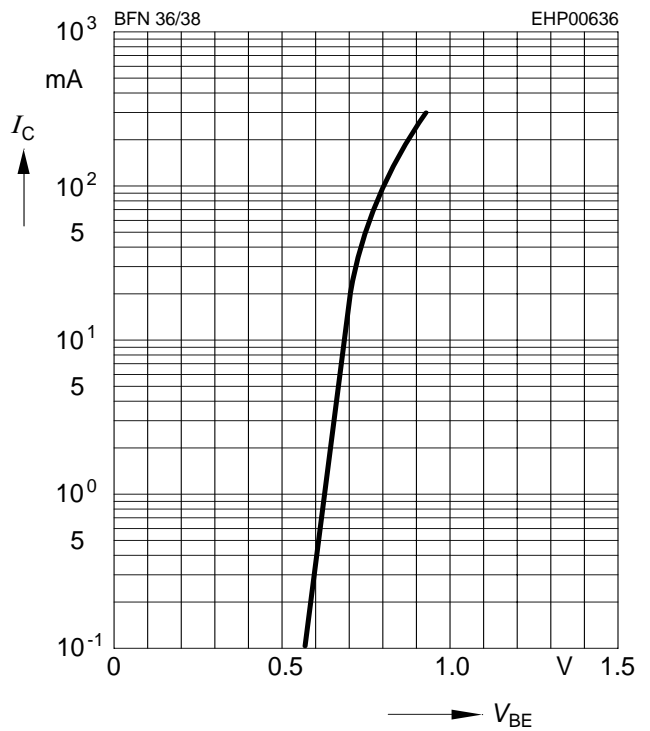

**Collector cutoff current  $I_{CBO} = f(T_A)$**

$V_{CB} = 30\text{ V}$

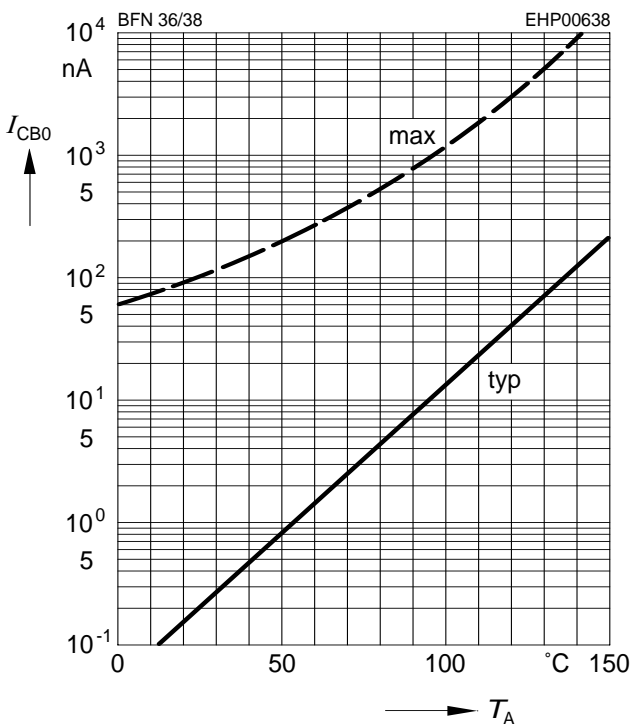

**Transition frequency  $f_T = f(I_C)$**

$V_{CE} = 10\text{ V}, f = 100\text{ MHz}$

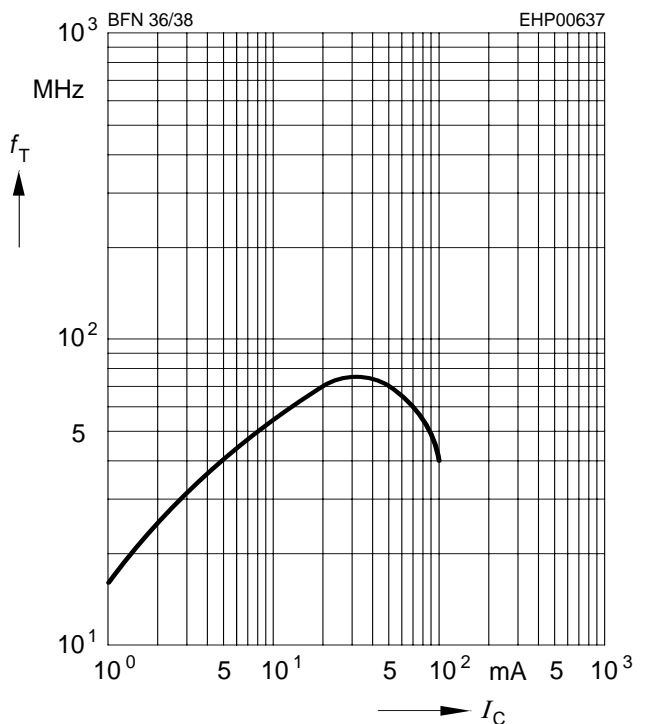

Collector-base capacitance  $C_{cb} = f(V_{CB})$

Emitter-base capacitance  $C_{eb} = f(V_{EB})$

Total power dissipation  $P_{tot} = f(T_S)$

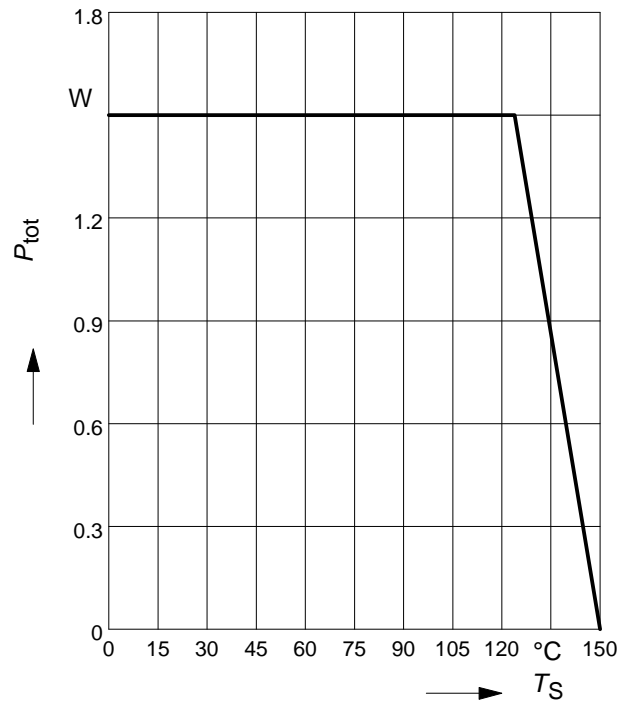
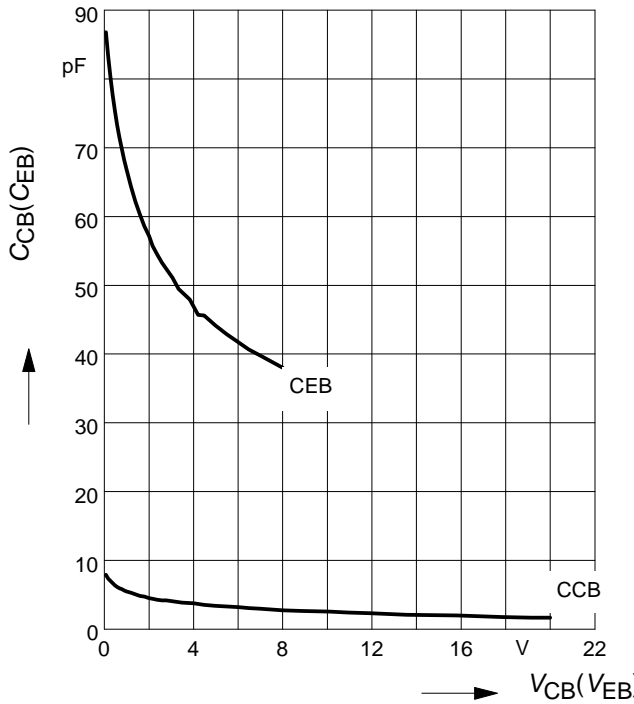

**Permissible Pulse Load**

$P_{totmax}/P_{totDC} = f(t_p)$

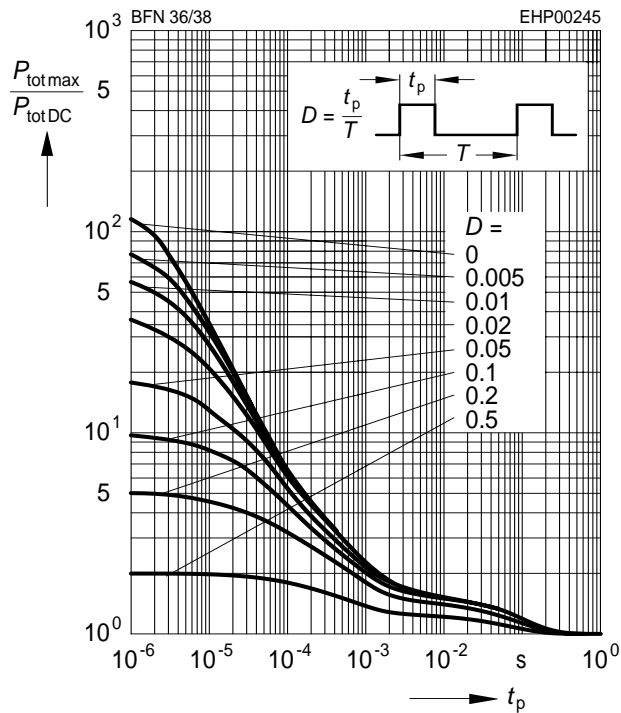

Package Outline

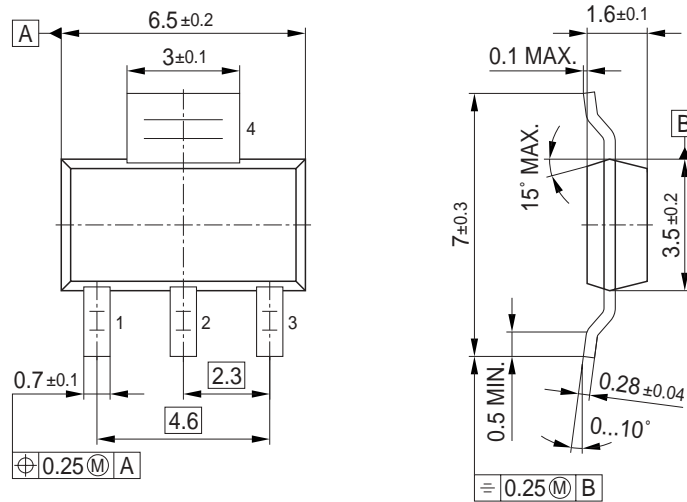

Foot Print

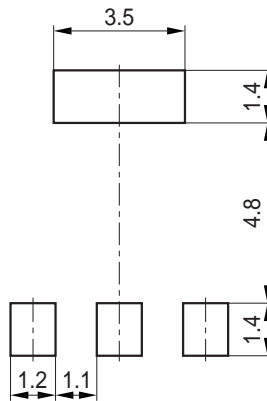

Marking Layout (Example)

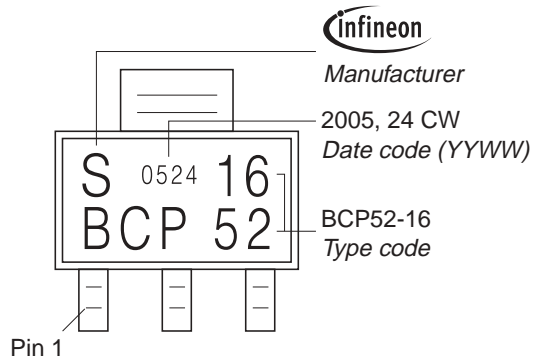

Packing

Reel  $\varnothing 180$  mm = 1.000 Pieces/Reel  
 Reel  $\varnothing 330$  mm = 4.000 Pieces/Reel

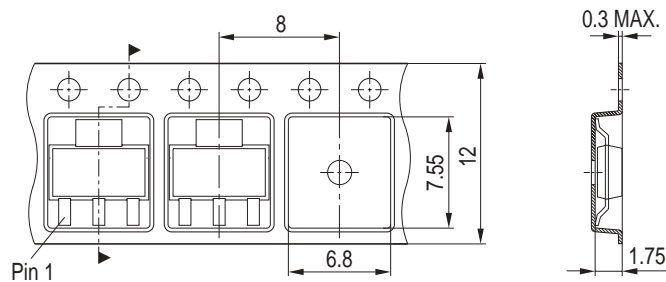

Edition 2006-02-01

Published by

Infineon Technologies AG

81726 München, Germany

© Infineon Technologies AG 2007.

All Rights Reserved.

### **Attention please!**

The information given in this dokument shall in no event be regarded as a guarantee of conditions or characteristics ("Beschaffenheitsgarantie"). With respect to any examples or hints given herein, any typical values stated herein and/or any information regarding the application of the device, Infineon Technologies hereby disclaims any and all warranties and liabilities of any kind, including without limitation warranties of non-infringement of intellectual property rights of any third party.

### **Information**

For further information on technology, delivery terms and conditions and prices please contact your nearest Infineon Technologies Office ([www.infineon.com](http://www.infineon.com)).

### **Warnings**

Due to technical requirements components may contain dangerous substances. For information on the types in question please contact your nearest Infineon Technologies Office.

Infineon Technologies Components may only be used in life-support devices or systems with the express written approval of Infineon Technologies, if a failure of such components can reasonably be expected to cause the failure of that life-support device or system, or to affect the safety or effectiveness of that device or system.

Life support devices or systems are intended to be implanted in the human body, or to support and/or maintain and sustain and/or protect human life. If they fail, it is reasonable to assume that the health of the user or other persons may be endangered.